

**ENGINES  
CNH  
F5C - F5A**

Structural and  
Non Structural Version

Repair

Manual

Tier III

Print No. 87736548A  
English



**ENGINES  
CNH  
F5C - F5A**

**Structural and Non Structural Version**

**4 Cylinders, Mechanical**

**Repair  
Manual  
Tier III**

---

# REPAIR INSTRUCTION MANUAL

## CNH ENGINES

**ENGINES FAMILY:**

**F5AE9484 - F5AE9454 - F5CE9484 - F5CE9454 - F5CE5454**

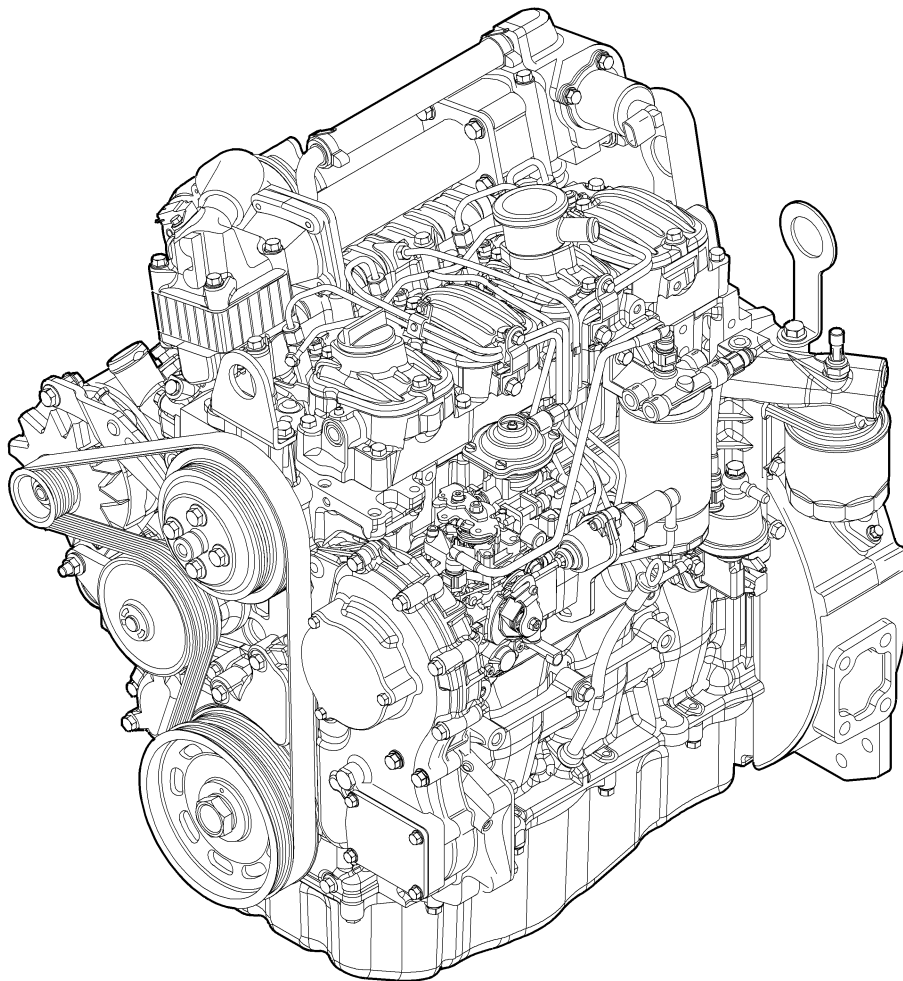

*All the information, illustrations and data provided by this manual are based upon the most recent information available at the time of its publication.*

*CNH ITALIA S.p.A. reserves the right to implement modifications, at any time, without communications.*



---

## FOREWORD

---

### TO THE READER

- This Manual is written for an expert technician to provide the technical information required to perform repair operations on this machine.
- Please read carefully this manual for the correct information regarding the repair procedures.
- For any question or comment, or in case any error regarding the content of this manual is found, you are asked to please contact:

CNH ITALIA S.p.A.  
Strada Settimo, 323  
San Mauro Torinese (TO)  
10099 ITALIA  
PARTS & SERVICE  
Fax ++39 011 0077357

---

### SYMBOLS

This manual includes safety warning symbols and indications to recall the attention on possible personal injuries or damages to the machine.



This symbol recalls the attention to points relative to safety.

When you see this symbol, it is necessary to proceed with attention since there is the possibility of personal injuries.

Comply scrupulously with the precautions identified by this symbol.

The safety warning symbol is also used to attract attention to the weight of a component or a part.

To prevent personal injuries or damages, make sure that the appropriate lifting equipment and techniques are implemented when handling heavy loads.

---

---

---

**FOREWORD**

---

**UNITS OF MEASURE**

In this manual, the units of measure of the IS (International System) are used.

The units of measure of the MKSA system are listed in parenthesis after the units of the International system.

Example: 24.5 Mpa (250 kgf/cm<sup>2</sup>).

Here below, a conversion table of the units of the IS and some units of measure of other systems is listed. as a reference.

| Quantity | To convert from (SI) | into (Others)   | Multiply by | Quantity    | To convert from (SI) | into (Others)       | Multiply by   |
|----------|----------------------|-----------------|-------------|-------------|----------------------|---------------------|---------------|
| Length   | mm                   | in              | 0.03937     | Pressure    | MPa                  | kgf/cm <sup>2</sup> | 10.197        |
|          | mm                   | ft              | 0.003281    |             | MPa                  | psi                 | 145.0         |
| Volume   | L                    | US gal          | 0.2642      | Power       | kW                   | PS                  | 1.360         |
|          | L                    | US qt           | 1.057       |             | kW                   | HP                  | 1.341         |
|          | m <sup>3</sup>       | yd <sup>3</sup> | 1.308       | Temperature | °C                   | °F                  | °C x 1.8 + 32 |
| Mass     | kg                   | lb              | 2.205       | Velocity    | km/h                 | mph                 | 0.6214        |
| Force    | N                    | kgf             | 0.10197     |             | min <sup>-1</sup>    | rpm                 | 1.0           |
|          | N                    | lbf             | 0.2248      | Flow        | L/min                | US gpm              | 0.2642        |
| Torque   | N.m                  | kgf.m           | 0.10197     |             | mL/rev               | cc/rev              | 1.0           |
|          | N.m                  | lbf.ft          | 0.7375      |             |                      |                     |               |

**SPECIAL REMARKS**

Diagrams and symbols have been widely used to give a clearer and more immediate illustration of the subject being dealt with, (see next page) instead of giving descriptions of some operations or procedures.

Example

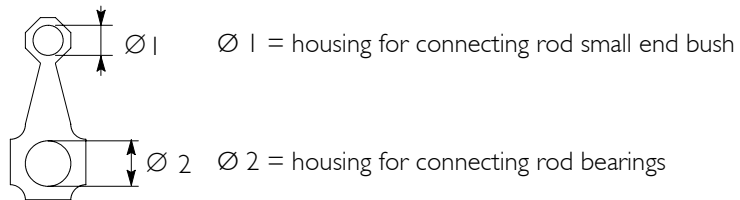

Tighten to torque  
Tighten to torque + angular value

**UPDATING**

| <b>Section</b> | <b>Description</b> | <b>Page</b> | <b>Date of revision</b> |
|----------------|--------------------|-------------|-------------------------|
|                |                    |             |                         |

**Introduction**

|   | Page |
|---|------|
| PREFACE TO USER'S GUIDELINE MANUAL . . . .                          | 3    |
| SYMBOLS . . . . .   | 3    |
| <input type="checkbox"/> Warnings . . . . .                         | 3    |
| <input type="checkbox"/> Service operations . . . . .               | 3    |
| GENERAL WARNINGS . . . . .  | 5    |
| GENERAL WARNINGS<br>ON THE ELECTRIC SYSTEM . . . . .                | 7    |
| <input type="checkbox"/> Bonding and screening . . . . .            | 8    |
| OPTIONAL ELECTRICAL AND MECHANICAL<br>PARTS INSTALLATIONS . . . . . | 9    |





## PREFACE TO USER'S GUIDELINE MANUAL

Manuals for repairs are split into Parts and Sections, each one of which is marked by a numeral; the contents of these sections are indicated in the general table of contents.

The sections dealing with things mechanic introduce the specifications, tightening torque values, tool lists, assembly detaching/reattaching operations, bench overhauling operations, diagnosis procedures and maintenance schedules.

The sections (or parts) of the electric/electronic system include the descriptions of the electric network and the assembly's electronic systems, wiring diagrams, electric features of components, component coding and the diagnosis procedures for the control units peculiar to the electric system.

Section 1 describes the engines illustrating its features and working in general.

Section 2 describes the type of fuel feed.

Section 3 relates to the specific duty and is divided in four separate parts:

1. Mechanical part, related to the engine overhaul, limited to those components with different characteristics based on the relating specific duty.

2. Electrical part, concerning wiring harness, electrical and electronic equipment with different characteristics based on the relating specific duty.

3. Maintenance planning and specific overhaul.

4. Troubleshooting part dedicated to the operators who, being entitled to provide technical assistance, shall have simple and direct instructions to identify the cause of the major inconveniences.

Sections 4 and 5 illustrate the overhaul operations of the engine overhaul on stand and the necessary equipment to execute such operations.

The appendix contains a list of the general safety regulations to be respected by all installation and maintenance engineers in order to prevent serious accidents taking place.

The manual uses proper symbols in its descriptions; the purpose of these symbols is to classify contained information. In particular, there have been defined a set of symbols to classify warnings and a set for assistance operations.

## SYMBOLS - Warnings



### Danger for persons

Missing or incomplete observance of these prescriptions can cause serious danger for persons' safety.



### Danger of serious damage for the assembly

Failure to comply, both fully or in part, with such prescriptions will involve serious damage to the assembly and may sometimes cause the warranty to become null and void.



### General danger

It includes the dangers of above described signals.



### Environment protection

Moreover, it describes the correct actions to be taken to ensure that the assembly is used in such a way so as to protect the environment as much as possible.

**NOTE** It indicates an additional explanation for a piece of information.

## Service operations

Example

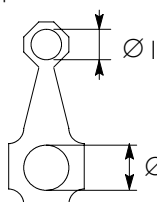



































Ø 1 = housing for connecting rod small end bush

Ø 2 = housing for connecting rod bearings



Tighten to torque

Tighten to torque + angular value

|   |   |   |   |
|---|---|---|---|
|    | Removal<br>Disconnection                    |    | Intake  |
|    | Refitting<br>Connection                     |    | Exhaust                                       |
|    | Removal<br>Disassembly                      |    | Operation                                     |
|    | Fitting in place<br>Assembly                |    | Compression ratio                             |
|    | Tighten to torque                           |    | Tolerance<br>Weight difference                |
|    | Tighten to torque + angle value             |    | Rolling torque                                |
|    | Press or caulk                              |    | Rotation                                      |
|    | Regulation<br>Adjustment                    |    | Angle<br>Angular value                        |
|   | Warning<br>Note                             |   | Preload                                       |
|  | Visual inspection<br>Fitting position check |  | Number of revolutions                         |
|  | Measurement<br>Value to find<br>Check       |  | Temperature                                   |
|  | Equipment                                   |  | Pressure                                      |
|  | Surface for machining<br>Machine finish     |  | Oversized<br>Higher than....<br>Maximum, peak |
|  | Interference<br>Strained assembly           |  | Undersized<br>Less than....<br>Minimum        |
|  | Thickness<br>Clearance                      |  | Selection<br>Classes<br>Oversizing            |
|  | Lubrication<br>Damp<br>Grease               |  | Temperature < 0 °C<br>Cold<br>Winter          |
|  | Sealant<br>Adhesive                         |  | Temperature > 0 °C<br>Hot<br>Summer           |
|  | Air bleeding                                |   |   |

## GENERAL WARNINGS



Warnings shown cannot be representative of all danger situations possibly occurring. Therefore, it is suggested to contact immediate superiors where a danger situation occurs which is not described.

Use both specific and general-purpose toolings according to the prescriptions contained in respective use and maintenance handbooks. Check use state and suitability of tools not subjected to regular check.

The manual handling of loads must be assessed in advance because it also depends, besides weight, on its size and on the path.

Handling by mechanical means must be with hoisters proper as for weight as well as for shape and volume. Hoisters, ropes and hooks used must contain clear indications on maximum carrying capacity acceptable. The use of said means is compulsorily permitted to authorised personnel only. Stay duly clear of the load, and, anyhow, never under it.

In disassembling operations, always observe provided prescriptions; prevent mechanical parts being taken out from accidentally striking workshop personnel.

Workshop jobs performed in pairs must always be performed in maximum safety; avoid operations which could be dangerous for the co-operator because of lack of visibility or of his/her not correct position.

Keep personnel not authorised to operations clear of working area.

You shall get familiar with the operating and safety instructions for the assembly prior to operating on the latter. Strictly follow all the safety indications found on the assembly.

Do not leave the running assembly unattended when making repairs.

When carrying out work on the assembly lifted off the ground, verify that the assembly is firmly placed on its supporting stands, and that the manual/automatic safety devices have been actuated in the event that the assembly is to be lifted by means of a hoist.

When you have to operate on assemblies powered by natural gas, follow the instructions contained in the document, as well as all the specific safety standards provided for.

Only remove radiator cap when the engine is cold by cautiously unscrewing it in order to let system residual pressure out.

Inflammable fuel and all inflammable fluids and liquids must be handled with care, according to what contained on harmful materials I 2-point cards. Refuelling must be performed outdoors with the engine off, avoiding lit cigarettes, free flames or sparks in order to prevent sudden fires/bursts. Adequately store inflammable, corrosive and polluting fluids and liquids according to what provided by regulations in force. Compulsorily avoid to use food containers to store harmful liquids. Avoid to drill or bore pressurised containers, and throw cloths impregnated with inflammable substances into suitable containers.

Worn out, damaged or consumable parts must be replaced by original spares.

During workshop activity, always keep the work place clean; timely clear or clean floors from accidental liquid or oil spots. Electric sockets and electric equipment necessary to perform repair interventions must meet safety rules.



Put on, where required by the intervention, garments and protections provided in accident prevention rules; contact with moving parts can cause serious injuries. Use suitable, preferably tight-fitted garments, and avoid to use jewels, scarves, etc.

Do not leave the engine in motion at workshop locations not provided with a pipe to scavenge exhaust gas outside.

Avoid to breathe fumes coming from heating or from paint welding because they can cause damages to health; operate outdoors or in suitably ventilated areas. Put on proper inspirator if paint powder is present.

Avoid contact with hot water or steam coming from the engine, radiator and pipings because they could cause serious burns. Avoid direct contact with liquids and fluids present in vehicle systems; where an accidental contact has occurred, refer to 12-point cards for provisions to make.



Clean the assemblies and carefully verify that they are intact prior to overhauling. Tidy up detached or disassembled parts with their securing elements (screws, nuts, etc.) into special containers.

Check for the integrity of the parts which prevent screws from being unscrewed: broken washers, dowels, clips, etc. Self-locking nuts with an insert made of nylon must always be replaced.

Avoid contact of rubber parts with diesel oil, petrol or other not compatible substances.

Before washing under pressure mechanical parts, protect electric connectors, and central units, if present.

Tightening screws and nuts must always be according to prescriptions; CNH commercial and assistance network is available to give all clarifications necessary to perform repair interventions not provided in this document.

Before welding:

- Disconnect all electronic central units, take power cable off battery positive terminal (connect it to chassis bonding) and detach connectors.**
- Remove paint by using proper solvents or paint removers and clean relevant surfaces with soap and water.**
- Await about 15 minutes before welding.**
- Equip with suitable fire resistant protections to protect hoses or other components where fluids or other materials flow which may catch fire easily on welding.**

Should the vehicle be subjected to temperatures exceeding 80°C (dryer ovens), disassemble drive electronic central units.



The disposal of all liquids and fluids must be performed with full observance of specific rules in force.

## GENERAL WARNINGS ON THE ELECTRIC SYSTEM



If an intervention has to be made on the electric/electronic system, disconnect batteries from the system; in this case, always disconnect, as a first one, the chassis bonding cable from batteries negative terminal.

Before connecting the batteries to the system, make sure that the system is well isolated.

Disconnect the external recharging apparatus from the public utility network before taking apparatus pins off battery terminals.

Do not cause sparks to be generated in checking if the circuit is energised.

Do not use a test lamp in checking circuit continuity, but only use proper control apparatuses.

Make sure that the electronic devices wiring harnesses (length, lead type, location, strapping, connection to screening braiding, bonding, etc.) comply with CNH system and are carefully recovered after repair or maintenance interventions.

Measurements in drive electronic central units, plugged connections and electric connections to components can only be made on proper testing lines with special plugs and plug bushes. Never use improper means like wires, screwdrivers, clips and the like in order to avoid the danger of causing a short circuit, as well as of damaging plugged connections, which would later cause contact problems.



To start up the engine, do not use fast chargers. Start up must only be performed with either separate batteries or special truck.

A wrong polarisation of supply voltage in drive electronic central units (for instance, a wrong polarisation of batteries) can cause them to be destroyed.

Disconnect the batteries from the system during their recharging with an external apparatus.

On connecting, only screw up connector (temperature sensors, pressure sensors etc.) nuts at prescribed tightening torque.

Before disconnecting the junction connector from an electronic central unit, isolate the system.

Do not directly supply electronic central units servo components at nominal vehicle voltage.

Cables must be arranged such as to result to be parallel to reference plane, i.e. as close as possible to chassis/body structure.

Once the intervention on the electric system has been completed, recover connectors and wiring harnesses according to original arrangement.

**NOTE** Connectors present must be seen from cable side. Connectors views contained in the manual are representative of cable side.

### Bonding and screening

Negative leads connected to a system bonding point must be both as short and possible and "star"-connected to each other, trying then to have their centering tidily and properly made (Figure 1, re. M).

Further, following warnings are to be compulsorily observed for electronic components:

- Electronic central units must be connected to system bonding when they are provided with a metallic shell.
- Electronic central units negative cables must be connected both to a system bonding point such as the dashboard opening bonding (avoiding "serial" or "chain" connections), and to battery negative terminal.
- Analog bonding (sensors), although not connected to battery negative system/terminal bonding, must have optimal isolation. Consequently, particularly considered must be parasitic resistances in lugs: oxidising, clinching defects, etc.
- Screened circuits braiding must only electrically contact the end towards the central unit entered by the signal (Figure 2).
- If junction connectors are present, unscreened section **d**, near them, must be as short as possible (Figure 2).
- Cables must be arranged such as to result to be parallel to reference plane, i.e. as close as possible to chassis/body structure.

Figure 1

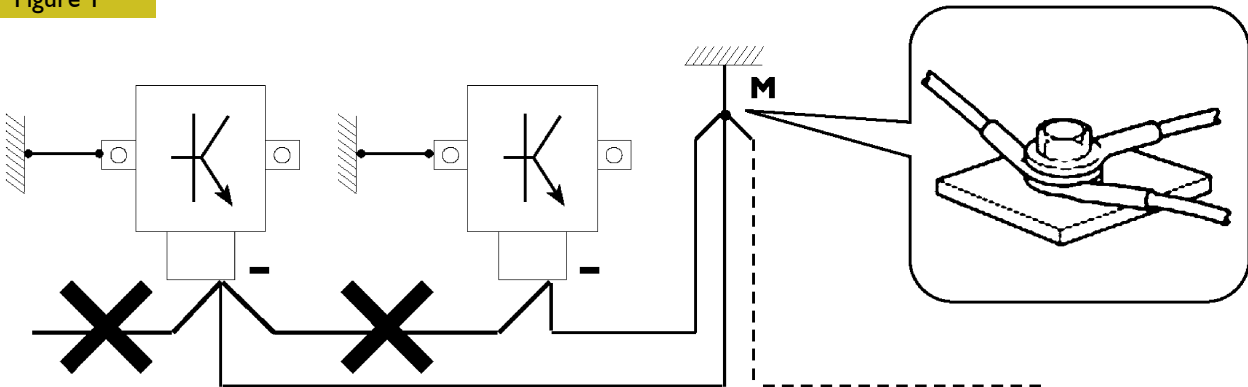

1. NEGATIVE CABLES "STAR" CONNECTION TO SYSTEM BONDING M

Figure 2

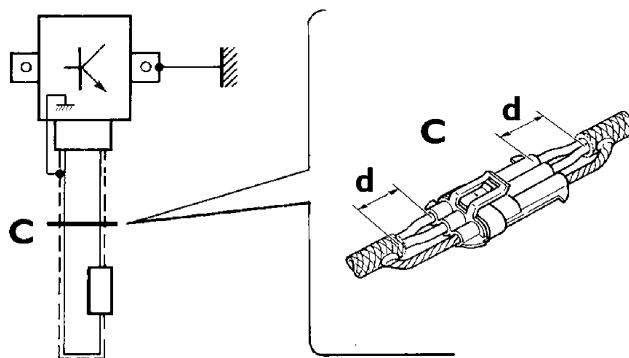

2. SCREENING THROUGH METALLIC BRAIDING OF A CABLE TO AN ELECTRONIC COMPONENT – C. CONNECTOR  
d. DISTANCE → 0

## OPTIONAL ELECTRICAL AND MECHANICAL PARTS INSTALLATIONS

Assemblies shall be modified and equipped with additions - and their accessories shall be fitted - in accordance with the assembling directives issued.

It is reminded that, especially about the electric system, several electric sockets are provided for as series (or optional) sockets in order to simplify and normalise the electrical intervention that is care of preparation personnel.



It is absolutely forbidden to make modifications or connections to electric central units wiring harnesses; in particular, the data interconnection line between central units (CAN line) is to be considered inviolable.





## F5 ENGINES

Section

F5CE Engines

**Part 1**

F5AE Engines

**Part 2**



**Thanks very much for your reading,  
Want to get more information,  
Please click here, Then get the complete  
manual**

**JustClickHere** 

**NOTE:**

**If there is no response to click on the link above,  
please download the PDF document first, and then  
click on it.**

**Have any questions please write to me:  
[admin@servicemanualperfect.com](mailto:admin@servicemanualperfect.com)**